

Model: TIE-20 TIE-40 TIE-50

20W
40W
54W



Long Life 10 years OK	Enclosed OK	100-277VAC 50-60Hz	PF ≥ 0.9	CRI ≥ 80	180°	IP64	5 years warranty	LED 2835	IES	UL US LISTED (LED LAMP) E364363	LM80	LM79
-----------------------------	----------------	-----------------------	--------------------	--------------------	------	------	---------------------	--------------------	------------	---	-------------	-------------

Specifications

Model No.	Power	led Qty	PF	CRI	Voltage	CCT	Lumen	Size mm (x 0.0393=inch)	Operation temp (°C/°F)	Weight (lbs=kg*2.2)	Certificate	Equal to
GKS 38	20W	96leds 2835	≥0.9	≥80	100~277VAC 50~60Hz	2700~6500K	3000±2 00lm	E26 Φ 92*131	minus 40~60°C	NW0.46 kg	CE ROHS LM80 DCL cUL/UL LM79	100W HPS MHL
								E39 Φ 92*148	minus 40~140°F	GW0.58 kg		
GKS 38	40W	192leds 2835	≥0.9	≥80	100~277VAC 50~60Hz	2700~6500K	6000±2 00lm	E26 Φ 92*198	minus 40~60°C	NW0.76 kg	CE ROHS LM80 DCL cUL/UL LM79	200W HPS MHL
								E39 Φ 92*215	minus 40~140°F	GW0.90 kg		
GKS 38	54W	294leds 2835	≥0.9	≥80	100~277VAC 50~60Hz	2700~6500K	9000±2 00lm	E26 Φ 92*253	minus 40~60°C	NW 1.02 kg	CE ROHS LM80 DCL cUL/UL LM79	250W HPS MHL
								E39 Φ 92*272	minus 40~140°F	GW1.18 kg		

Features

2835 150lm/W



350 degree twistable



Flame retardant material



180 degree beam angle

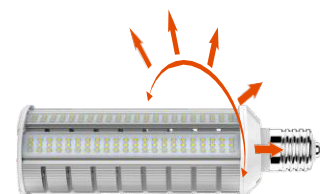

Application



Wall pack



Shoe box



Canopy



Low bay



Area light



Cobra Head



Before



After



Installation

Lamp Installation

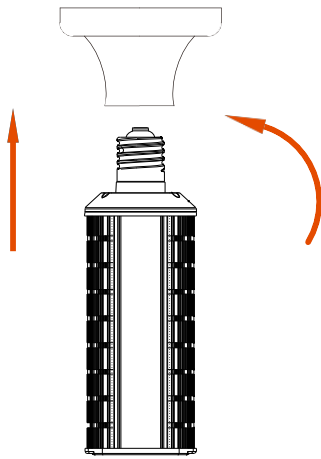

Step:1

Shown as Figure 1
Remove old ballast or disconnect from existing lamp holder. Remove and dispose of ballast in correct manner.
(North America 100-277VAC)

Step:2

Shown as Figure 2
Reconnect directly to the existing lamp holder.
(North America 100-277VAC)

Step:3

Shown as Figure 3
Install new LED replacement lamp. Please make sure the old fitting is correctly earth.
(North America 100-277VAC)

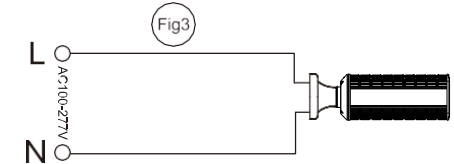
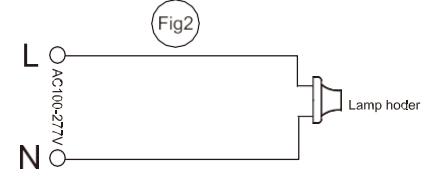
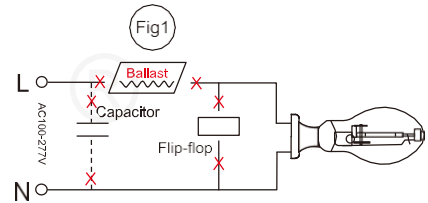

Support Stand Installation

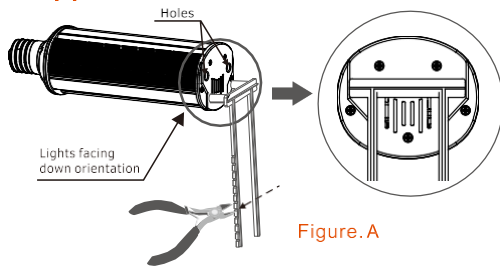

Figure. A

Instructions for two legs stand (shown as figure A):

- Step 1: Screw the lamp onto the socket tightly, then adjust the lamp slightly, make the LEDs side of lamp facing down orientation.
- Step 2: Fix the two legs acrylic stand onto the bottom of the lamp.
- Step 3: Cut off the excess part of the stand.

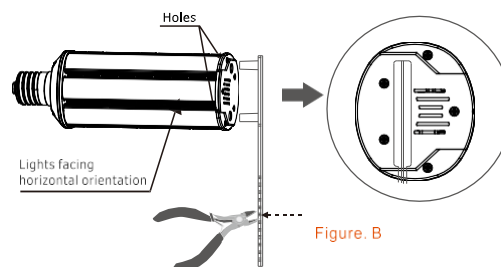

Figure. B

Instructions for one leg stand (shown as figure B):

- Step 1: Screw the lamp onto the socket tightly, then adjust the lamp slightly, make the LEDs side of lamp facing horizontal orientation.
- Step 2: Fix the one leg acrylic stand onto the bottom of the lamp.
- Step 3: Cut off the excess part of the stand.

Packing

Wattage	Inner box size	N.W per lamp (lbs=kg*2.2)	G.W per box (lbs=kg*2.2)	G.W per Carton (lbs=kg*2.2)	Carton Size	Quantity Per Carton
20W	93*93*190mm	11.04kg	0.58kg	13.97kg	390*296*396mm	24
40W	102*102*258mm	9.12kg	0.90kg	11.0kg	425*322*273mm	12
54W	102*102*305mm	12.24kg	1.18kg	14.21kg	425*322*320mm	

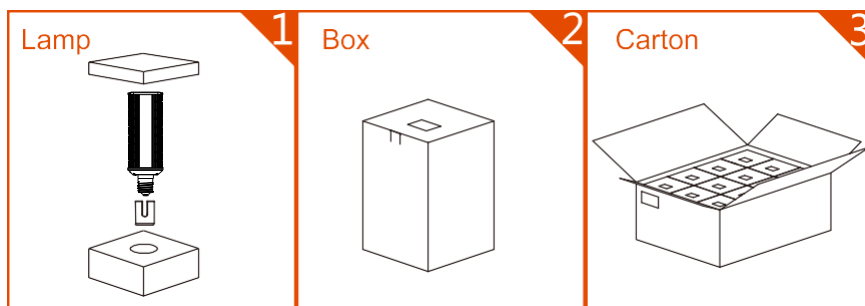

Pack Quantity:

20W:24pcs
40W 54W:12pcs

CAUTIONS

- Risk of electric shock. Do not use where directly exposed to water.
- Do not use with dimmers, timers, or other control devices.
- 20W 40W 54W are suitable for using in totally enclosed fixtures.
- Don't take apart the lamps without our permit.
- Please read carefully manual before installation.

